

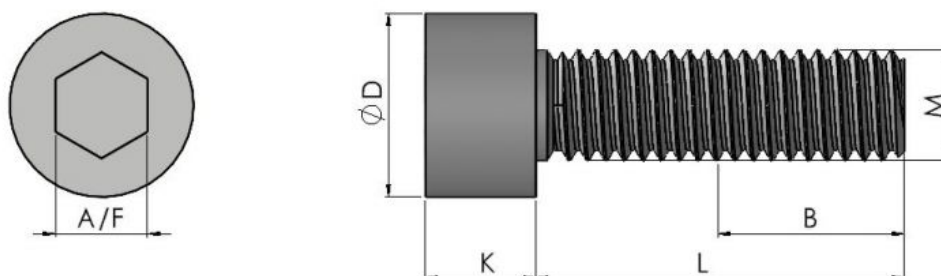

Series: 11702 Type: - DIN 912



Hexagon Socket Cap Head 8.8

Part No.	Thread	K	B if L longer than B	D	A/F
11702 M03**	M3	3.00	18.00	5.50	2.50
11702 M04**	M4	4.00	20.00	7.00	3.00
11702 M05**	M5	5.00	22.00	8.50	4.00
11702 M06**	M6	6.00	24.00	10.00	5.00
11702 M08**	M8	8.00	28.00	13.00	6.00
11702 M10**	M10	10.00	32.00	16.00	8.00
11702 M12**	M12	12.00	36.00	18.00	10.00
11702 M16**	M16	16.00	44.00	24.00	14.00
11702 M20**	M20	20.00	52.00	30.00	17.00
11702 M24**	M24	24.00	60.00	36.00	19.00

Legend	
*	Usually Available from Stock
**	Non-preferred (Possible Lead Times)
***	Special Order Only

Thread/Length	5	6	8	10	12	16	20	25	30	35	40	45	50	60	70	80	90	100	110	120	130	140	150	160	180	
M3	*	*	*	*	*	**	*	*	*	**	*	*	*	**	**	**	**	**	**	**	**	**	**	**	**	**
M4	**	**	*	*	*	**	*	**	*	**	*	*	*	**	**	**	**	**	**	**	**	**	**	**	**	**
M5	**	**	*	*	*	*	*	**	*	**	*	*	*	*	*	*	*	**	**	**	**	**	**	**	**	**
M6	**	**	*	*	*	*	*	*	*	*	*	*	*	*	*	*	*	*	**	**	*	**	**	**	**	**
M8	**	**	**	*	*	*	*	*	*	*	*	*	*	*	*	*	*	*	*	*	*	*	*	*	*	*
M10	**	**	**	**	**	**	*	*	*	*	*	*	*	*	*	*	*	*	*	*	*	*	*	*	*	*
M12	**	**	**	**	**	**	*	**	*	**	*	*	*	*	*	*	*	*	*	*	*	*	*	*	*	*
M16	**	**	**	**	**	**	**	**	**	**	*	*	*	*	*	*	*	*	*	*	*	*	*	*	*	*
M20	**	*	*	*	*	*	*	*	*	*	*	*	*	*	*	*	*	*	*	*	*	*	*	*	*	*



Continued from previous page...

Series: 11702 Type: - DIN 912

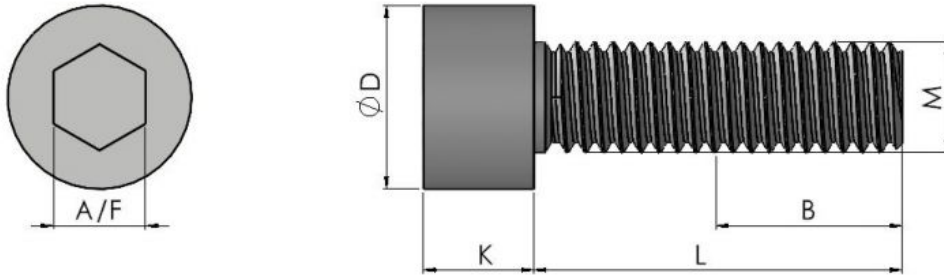

*





Continued from previous page...

Series: 11702 Type: - DIN 912

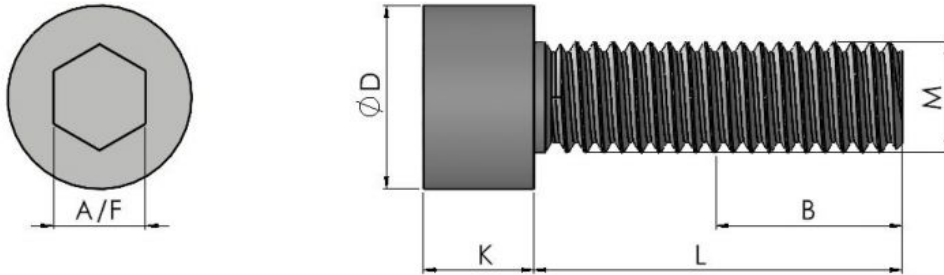

*





Continued from previous page...

Series: 11702 Type: - DIN 912

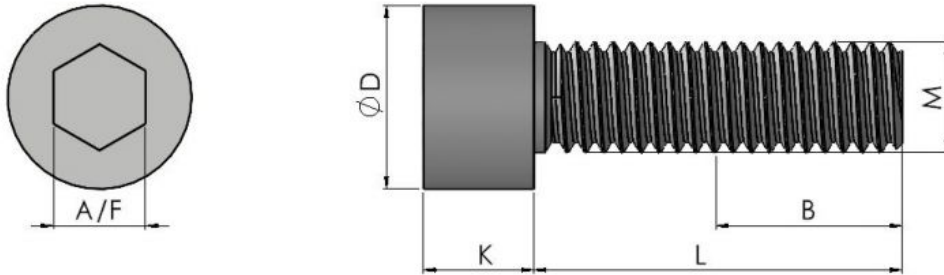

*





Continued from previous page...

Series: 11702 Type: - DIN 912

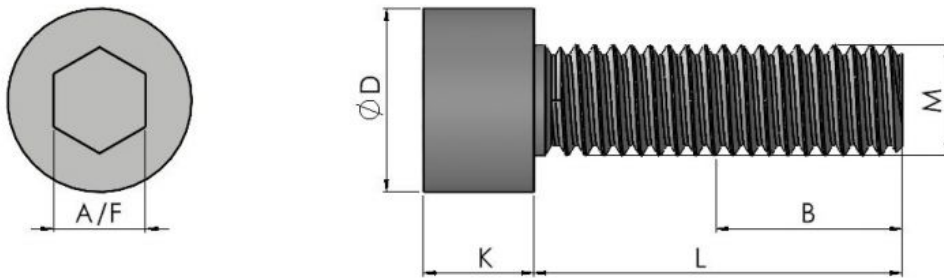

*





Continued from previous page...

Series: 11702 Type: - DIN 912

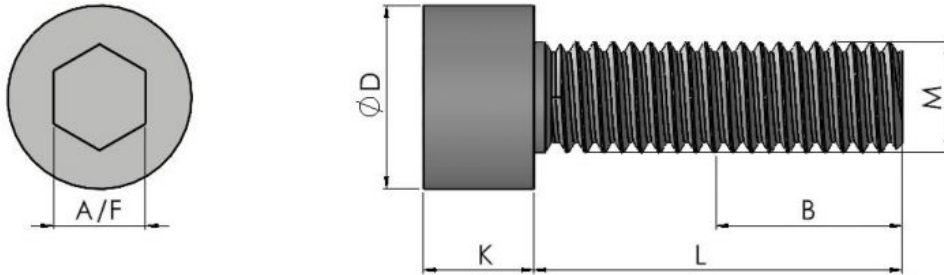

*





Continued from previous page...

Series: 11702 Type: - DIN 912

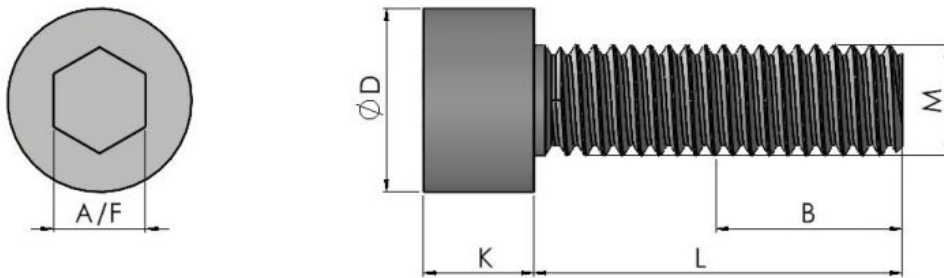

*





Continued from previous page...

Series: 11702 Type: - DIN 912

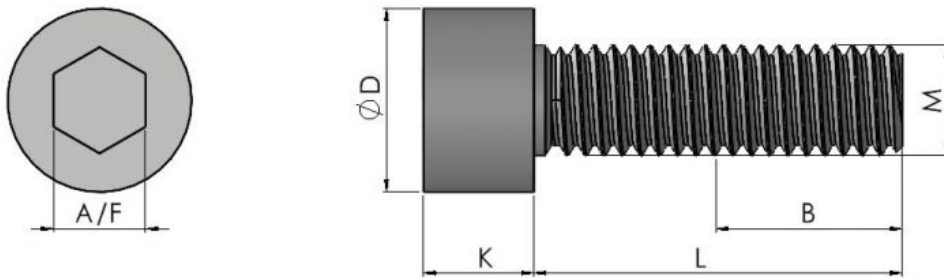

*





Continued from previous page...

Series: 11702 Type: - DIN 912

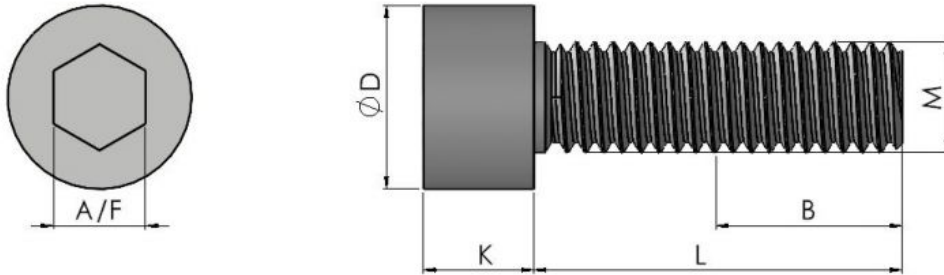

*





Continued from previous page...

Series: 11702 Type: - DIN 912

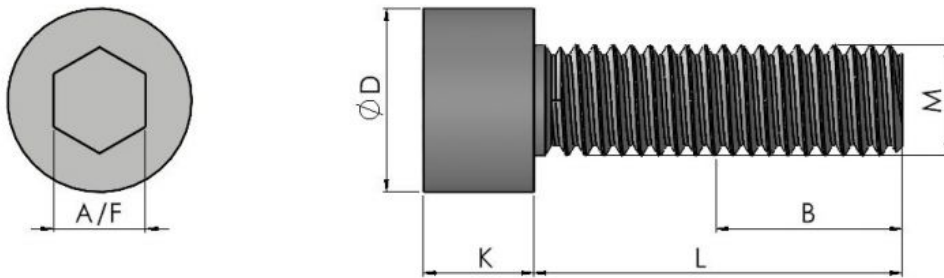

*





Continued from previous page...

Series: 11702 Type: - DIN 912

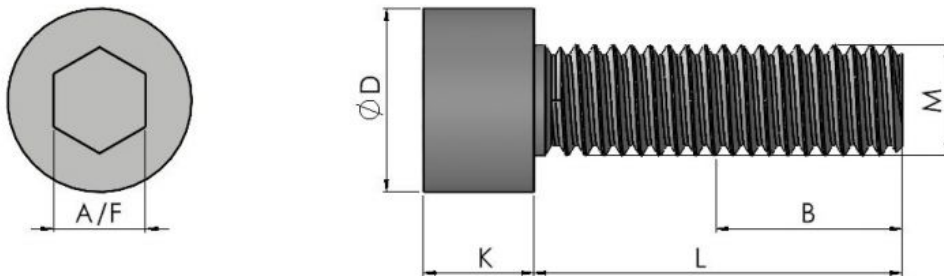

*





Continued from previous page...

Series: 11702 Type: - DIN 912

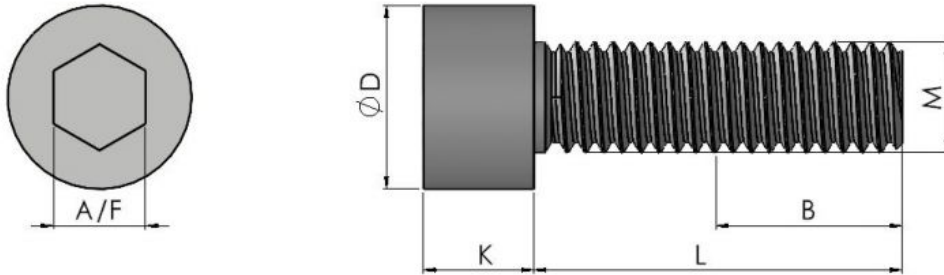

*





Continued from previous page...

Series: 11702 Type: - DIN 912

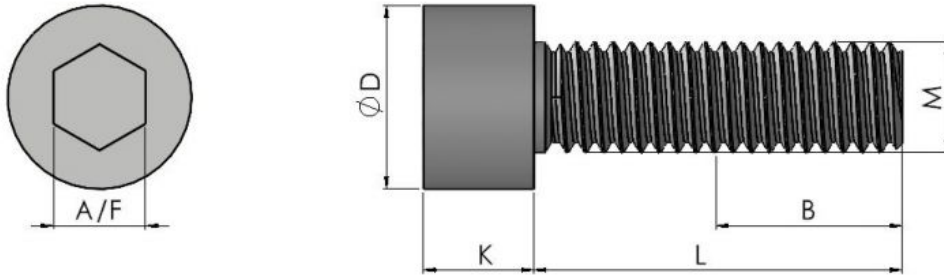

*





Continued from previous page...

Series: 11702 Type: - DIN 912

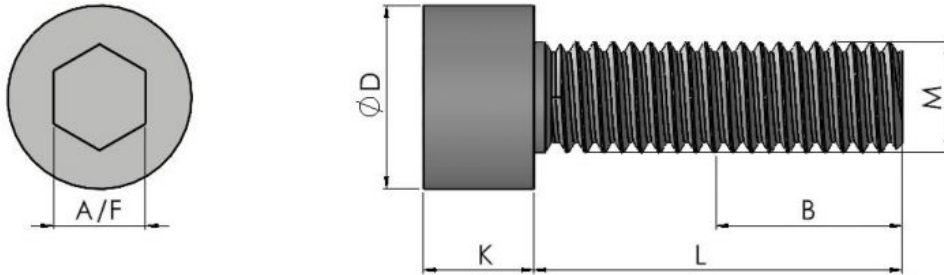

*





Continued from previous page...

Series: 11702 Type: - DIN 912

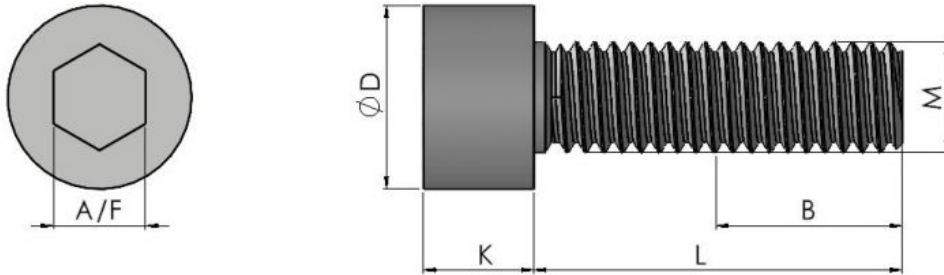

*





Continued from previous page...

Series: 11702 Type: - DIN 912

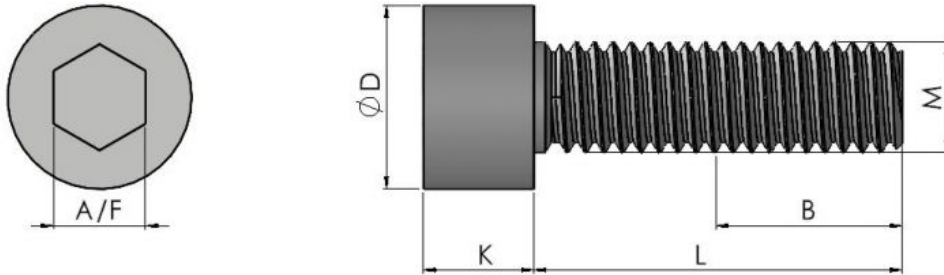

*





Continued from previous page...

Series: 11702 Type: - DIN 912

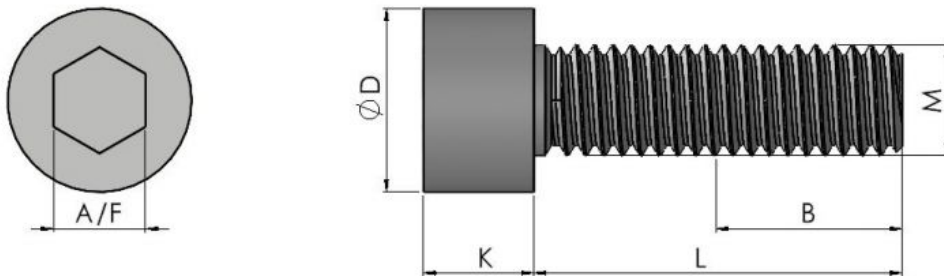

*





Continued from previous page...

Series: 11702 Type: - DIN 912

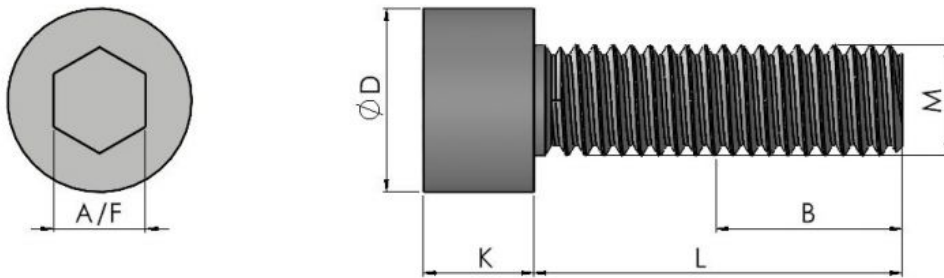

*

*	*	*	*	*	***	***	***	***
---	---	---	---	---	-----	-----	-----	-----



Continued from previous page...

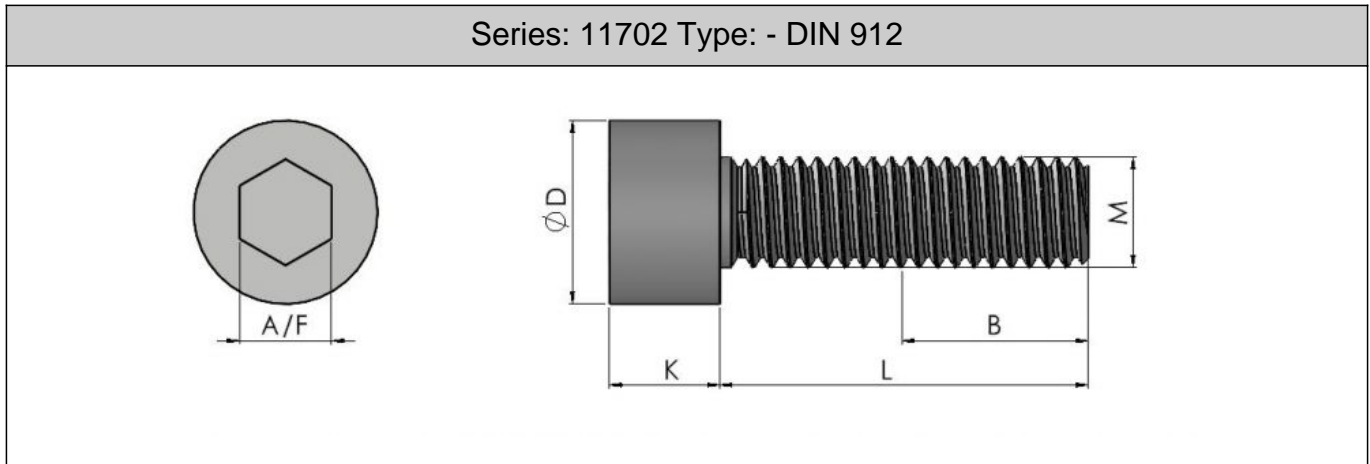

M24	**	**	**	**	**	**	**	**	**	**	**	**	**	**	*	*	*	*	*	**	*	**	*	*	***	*	***	*	***	***	***	
	*	*	*	*	*	*	*	*	*	*	*	*	*	*	*	*	*	*	*	*	*	*	*	*	*	*	*	*	*	*	*	*

Material/Finish/Finish Code:

Steel - Self Colour - 00Steel - Zinc Plated - 60Stainless Steel A2 - Self Colour - SSStainless Steel A4 - Self Colour - A4

Part Number ID:

Part No/Thread Length/grade/Finish CodeEg: 11702 M0616 60: M6 x 16 Zinc Clear 8.8

All information is given for guidance only and designers should satisfy themselves as to the suitability of the specification by requesting samples